

SHAFT DRIVE

M/C

CONTENTS

SECONDARY BEVEL GEARS	4- 2
CONSTRUCTION.....	4- 2
REMOVAL	4- 4
DISASSEMBLY	4- 4
INSPECTION	4- 5
SECONDARY GEAR SHIMS ADJUSTMENT	4- 6
REASSEMBLY	4- 9
INSTALLATION	4- 9
FINAL BEVEL GEARS	4-10
CONSTRUCTION.....	4-10
FINAL GEAR CASE REMOVAL	4-12
FINAL GEAR CASE DISASSEMBLY.....	4-12
FINAL GEAR SHIMS ADJUSTMENT	4-16
FINAL GEAR CASE REASSEMBLY	4-19
FINAL GEAR CASE INSTALLATION.....	4-23

SECONDARY BEVEL GEARS CONSTRUCTION

- A Secondary drive gear shaft nut
- B Secondary drive bevel gear bearing retainer bolt
- C Secondary driven bevel gear bolt
- 1 Bush
- 2 Overdriving driven gear
- 3 Circlip
- 4 Output cam dog
- 5 Damper spring
- 6 Secondary bevel gear set
- 7 Shims (5 kinds)
- 8 Driven bevel gear bearing
- 9 O-ring
- 10 Shims (5 kinds)
- 11 O-ring
- 12 Oil seal housing
- 13 Oil seal
- 14 Bearing stopper
- 15 Universal joint

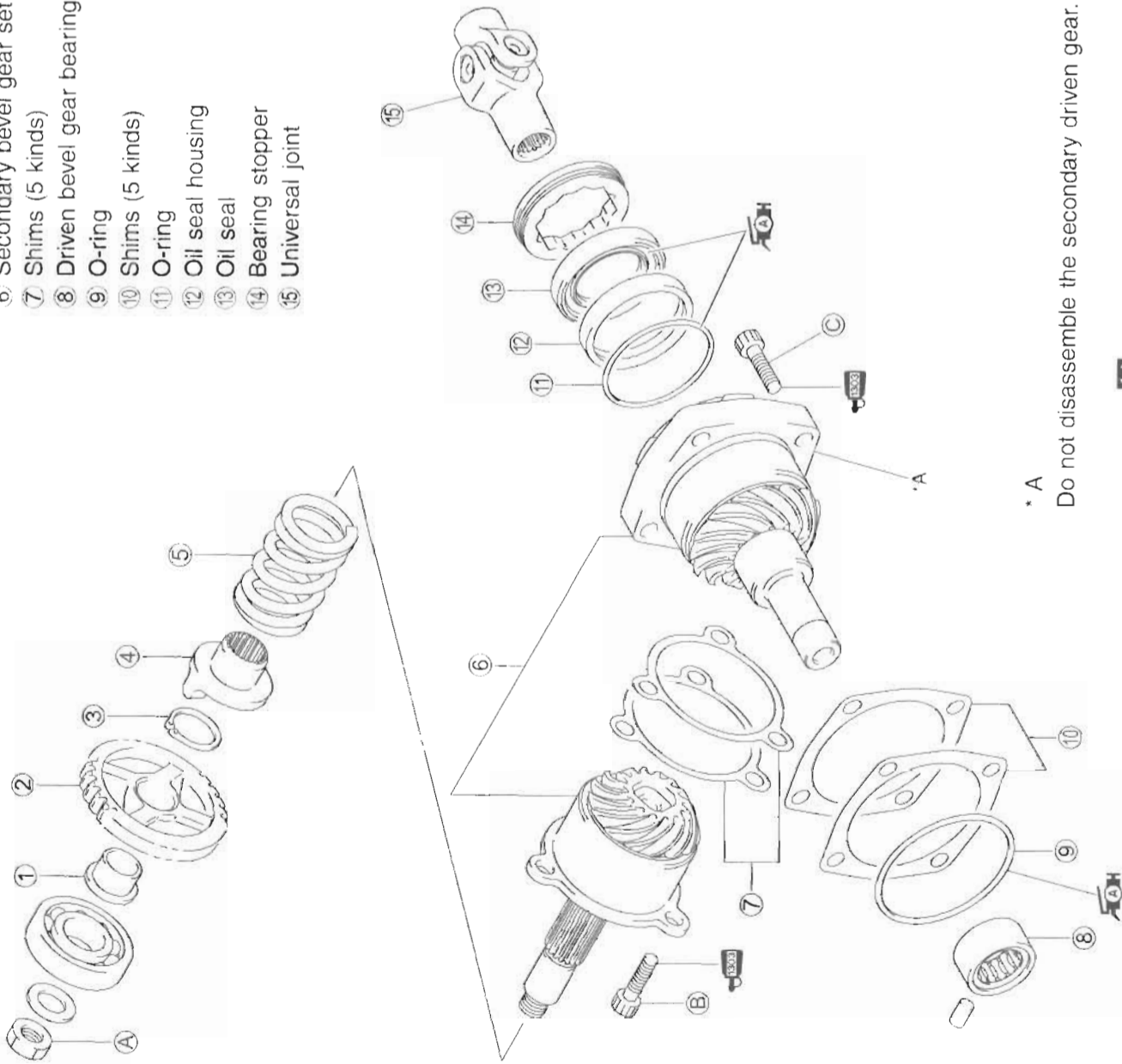

*A Do not disassemble the secondary driven gear.

ITEM	N·m	kgf·m	lb·ft
A	105	10.5	76.0
B, C	23	2.3	16.5

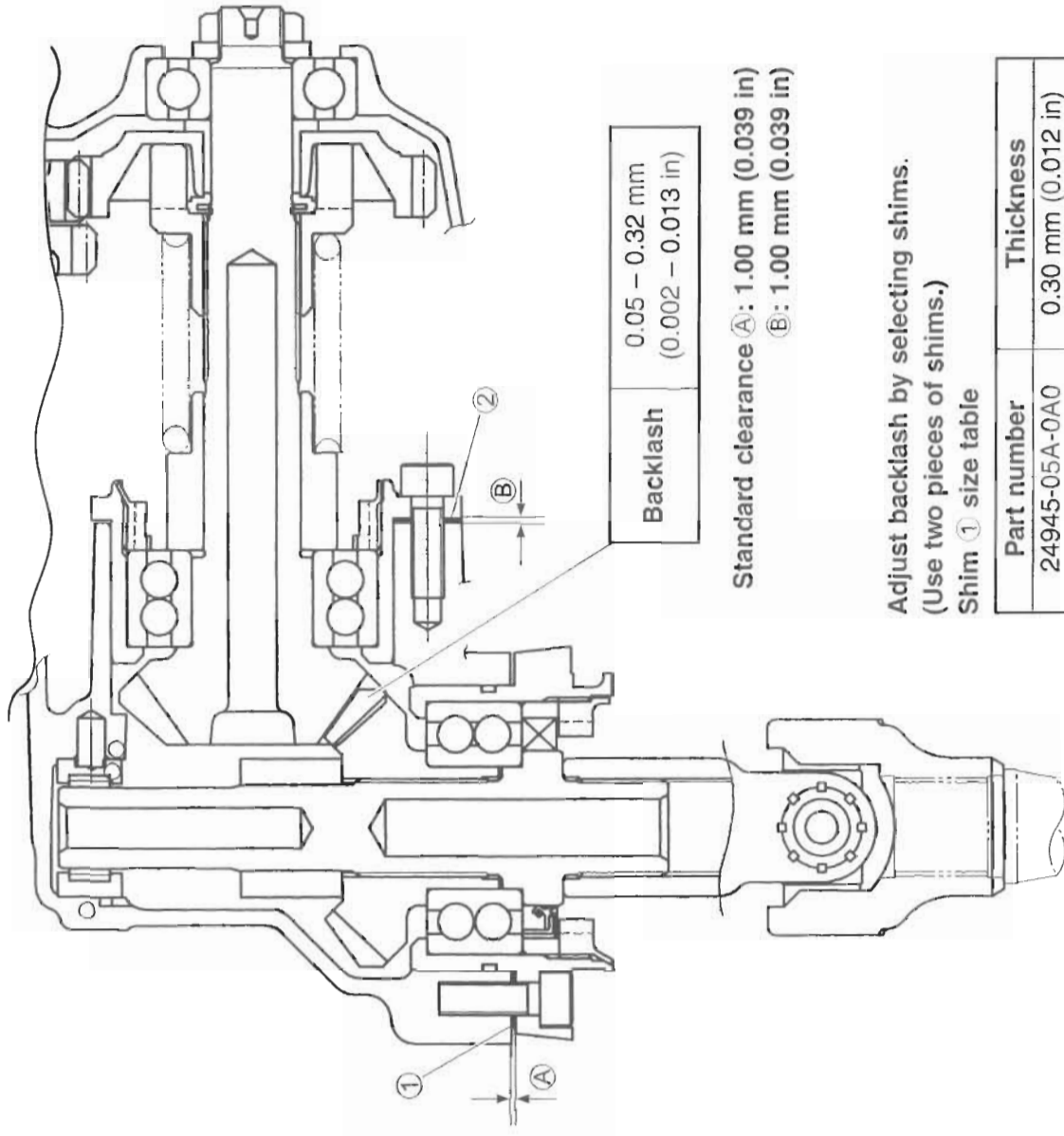

Standard clearance A: 1.00 mm (0.039 in)
 B: 1.00 mm (0.039 in)

Adjust backlash by selecting shims.
 (Use two pieces of shims.)

Shim 1 size table

Part number	Thickness
24945-05A-0A0	0.30 mm (0.012 in)
24945-05A-0B0	0.35 mm (0.014 in)
24945-05A-0C0	0.40 mm (0.016 in)
24945-05A-0D0	0.50 mm (0.020 in)
24945-05A-0E0	0.60 mm (0.024 in)

The shims 1 are available as a set (24945-05810).

Shim 2 size table

Part number	Thickness
24935-38A01-030	0.30 mm (0.012 in)
24935-38A01-035	0.35 mm (0.014 in)
24935-38A01-040	0.40 mm (0.016 in)
24935-38A01-050	0.50 mm (0.020 in)
24935-38A01-060	0.60 mm (0.024 in)

The shims 2 are available as a set (24935-38810).

REMOVAL

SECONDARY DRIVE BEVEL GEAR

The crankcase must be separated to service the secondary drive bevel gear. The secondary drive bevel gear service requires engine removal and disassembly. Refer to the engine removal and the engine disassembly sections for secondary drive bevel gear assembly removal.

Engine removal  3-3



Engine disassembly  3-11

SECONDARY DRIVEN BEVEL GEAR

The following components must be removed in the described order before removing the secondary driven bevel gear.

NOTE:

Refer to the following pages for the details of each step.

- Remove the rear wheel. ( 7-38)
- Remove the swingarm. ( 7-48)
- Remove the universal joint.
- Remove the secondary driven bevel gear.

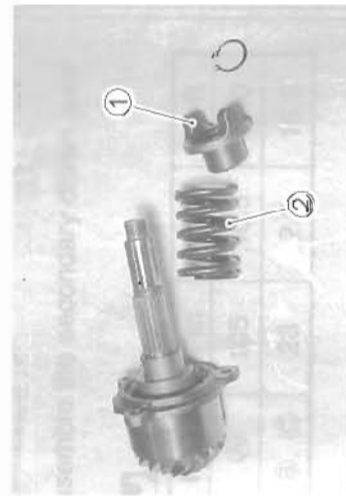
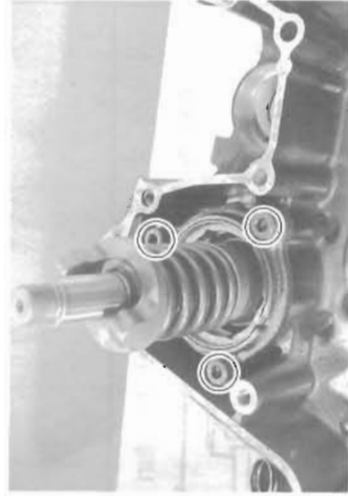

DISASSEMBLY

SECONDARY DRIVE BEVEL GEAR

- Compress the damper spring with a vice, and remove the circlip with the special tool.

 09900-06107: Snap ring pliers

- Remove the cam dog (1) and damper spring (2).

▲ CAUTION

Do not attempt to remove the secondary drive bevel gear bearing. The secondary drive bevel gear and its bearing are available only as an assembly.

SECONDARY DRIVEN BEVEL GEAR

- Remove the bearing stopper with the special tool.

 09921-21820: Bearing retainer wrench

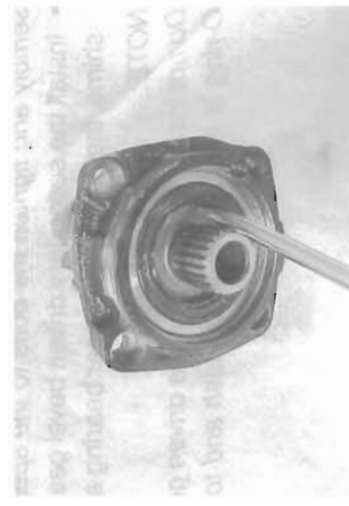

INSPECTION

Inspect the removed parts for the following abnormalities.

- Drive and driven bevel gears damage or wear
- Improper tooth contact
- Abnormal noise of bearings
- Bearing damage or wear
- Oil seal damage or wear
- Output cam dog wear or damage
- Universal joint spline damage or wear

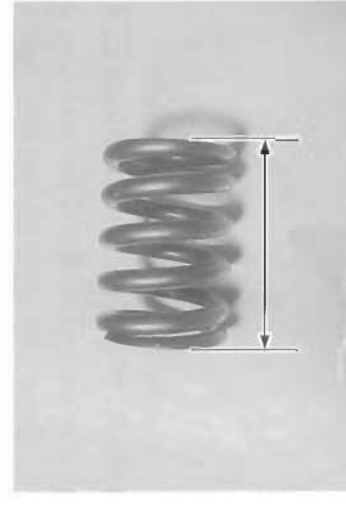

DAMPER SPRING

Measure the free length of the damper spring. If the length is shorter than the service limit, replace the spring with a new one.

 DATA Damper spring free length
Service limit: 58.5 mm (2.30 in)

SECONDARY GEAR SHIMS ADJUSTMENT BACKLASH

- Install the secondary drive bevel gear assembly with the removed shims and tighten the bolts to the specified torque.

Secondary drive bevel gear bearing retainer bolt:
23 N·m (2.3 kgf·m, 16.5 lb-ft)

NOTE:

When replacing the secondary drive and driven bevel gears, install the removed shims to the secondary drive bevel gear assembly and tighten the bolts to the specified torque.

- Install the secondary driven bevel gear assembly with removed shims, the driven bevel gear bearing and secondary gear case.

NOTE:

Do not install the O-ring on the driven gear housing at this stage. O-ring is installed after backlash and tooth contact are correct.

- Tighten the secondary bevel gear case bolts and secondary driven bevel gear bolts to the specified torque.

Secondary bevel gear case bolt:
22 N·m (2.2 kgf·m, 16.0 lb-ft)

Secondary driven bevel gear bolt:
23 N·m (2.3 kgf·m, 16.5 lb-ft)

NOTE:

* Hollow portion (A) of the secondary driven bevel gear assembly faces inside.

* It is not necessary to apply SUZUKI BOND "1207B" to the matching surface at this stage.

- Measure the backlash as follows.
 - Set-up a dial gauge as shown in photo.
- 09900-20606: Dial gauge (1/100 mm, 10 mm)**
09900-20701: Magnetic stand

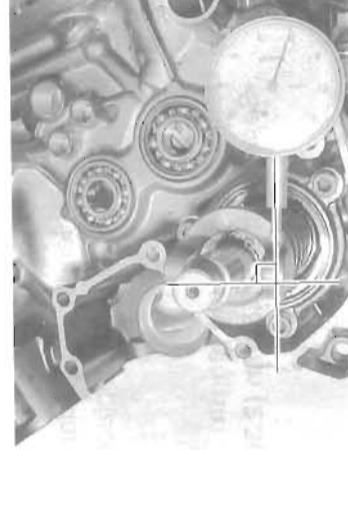
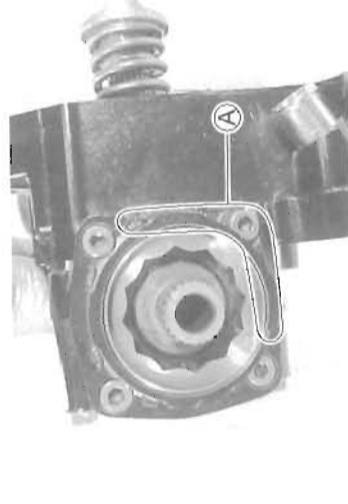
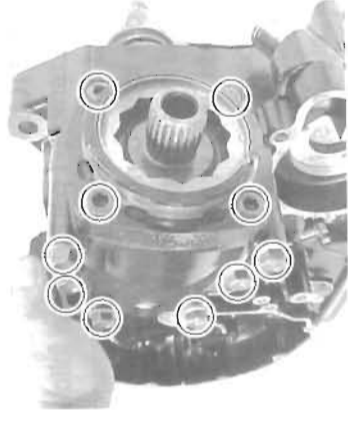
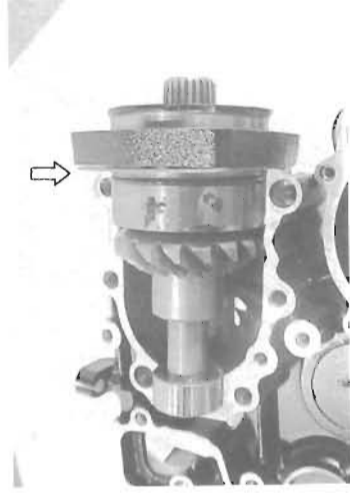
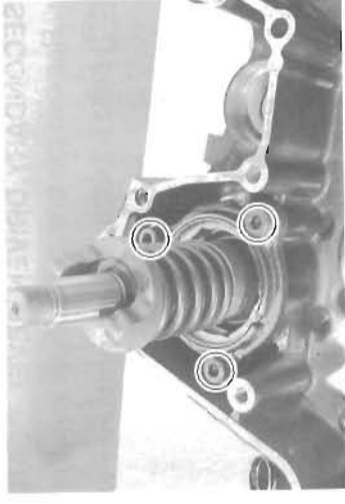

- Adjust the dial gauge so that it touches the secondary drive bevel gear cam dog; hold the driven bevel gear securely, and turn the drive bevel gear in each direction, reading the total backlash on the dial gauge.

Secondary bevel gear backlash
Standard: 0.05 – 0.32 mm (0.002 – 0.013 in)

NOTE:

When measuring backlash, hold the left crankcase horizontally pull the secondary drive gear to take the bearing play out.

- If the backlash is not within specification, the shims (Driven bevel gear side) must be changed and the backlash should be re-checked until correct.

Refer to the chart for appropriate changes.

NOTE:

When changing the shims (Driven bevel gear side), measure the thickness of old shims. Using the thickness of the old shims as a guide, adjust the backlash by referring to the chart.

Backlash	Shim adjustment
Under 0.05 mm (0.002 in)	Increase shim thickness
0.05 – 0.32 mm (0.002 – 0.013 in)	Correct
Over 0.32 mm (0.013 in)	Decrease shim thickness

SHIM SPECIFICATIONS

Drive bevel gear side

Part No.	Shim thickness
24935-38A01-030	0.30 mm (0.012 in)
24935-38A01-035	0.35 mm (0.014 in)
24935-38A01-040	0.40 mm (0.016 in)
24935-38A01-050	0.50 mm (0.020 in)
24935-38A01-060	0.60 mm (0.024 in)

NOTE:

The shims (drive bevel gear side) are available as a set (24935-38810).

Driven bevel gear side

Part No.	Shim thickness
24945-05A00-0A0	0.30 mm (0.012 in)
24945-05A00-0B0	0.35 mm (0.014 in)
24945-05A00-0C0	0.40 mm (0.016 in)
24945-05A00-0D0	0.50 mm (0.020 in)
24945-05A00-0E0	0.60 mm (0.024 in)

NOTE:

The shims (driven bevel gear side) are available as a set (24945-05810).

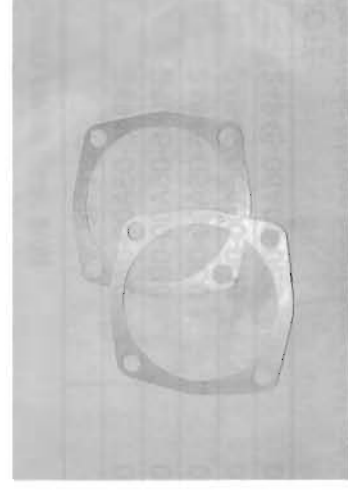
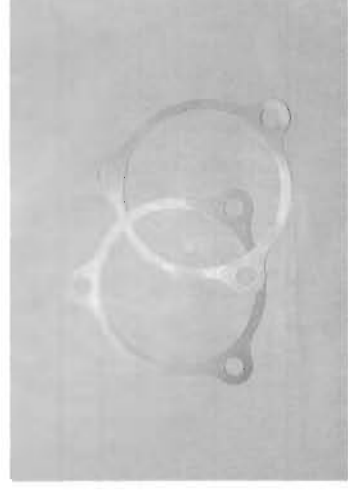
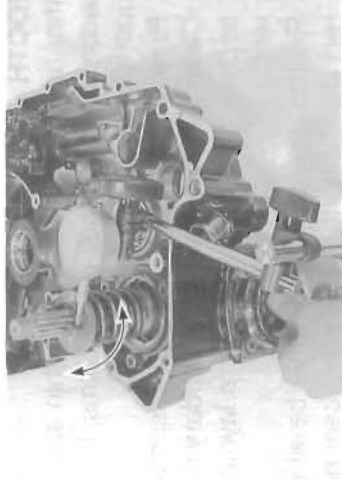

TOOTH CONTACT

After bringing the backlash within specification by changing the secondary driven bevel gear shims, it will be necessary to check tooth contact.

- Remove the drive bevel gear assembly from the crankcase.
- Clean and degrease the secondary drive bevel gear teeth, and apply a coating of machinist's layout dye or paste to several teeth.
- Reinstall the secondary drive bevel gear assembly with correct shim, onto the secondary driven gear housing.
- Rotate the secondary driven bevel gear several turns in both directions.
- Remove the secondary drive bevel gear from the crankcase, and observe the tooth contact pattern made in the dye or paste.
- Compare the tooth contact pattern to the examples as shown in ①, ② and ③.
- If tooth contact is found to be incorrect, the shims of the secondary drive bevel gear and secondary driven bevel gear must be changed, tooth contact should be re-checked until correct.

▲ CAUTION

After the tooth contact adjustment is made, the backlash must be re-checked, as it may change. Refer to the backlash checking sub-section, and readjust until both backlash and tooth contact are correct.

Tooth contact	Shim adjustment
Contact at tooth top ①	Decrease thickness of shims ④ or ⑤
Contact at tooth root ③	Increase thickness of shims ④ or ⑤

SHIM SPECIFICATIONS

Drive bevel gear side

Part No.	Shim thickness
24935-38A01-030	0.30 mm (0.012 in)
24935-38A01-035	0.35 mm (0.014 in)
24935-38A01-040	0.40 mm (0.016 in)
24935-38A01-050	0.50 mm (0.020 in)
24935-38A01-060	0.60 mm (0.024 in)

NOTE:

The shims (drive bevel gear side) are available as a set (24935-38810).

Driven bevel gear side

Part No.	Shim thickness
24945-05A00-0A0	0.30 mm (0.012 in)
24945-05A00-0B0	0.35 mm (0.014 in)
24945-05A00-0C0	0.40 mm (0.016 in)
24945-05A00-0D0	0.50 mm (0.020 in)
24945-05A00-0E0	0.60 mm (0.024 in)

NOTE:

The shims (driven bevel gear side) are available as a set (24945-35810).

① INCORRECT (Contact at tooth top)

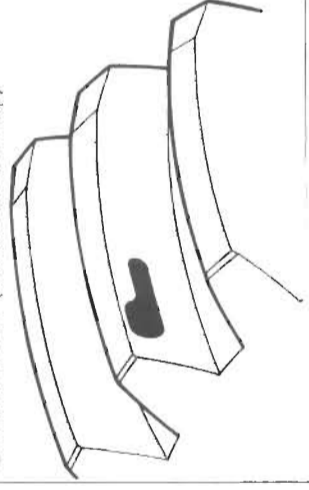

② CORRECT

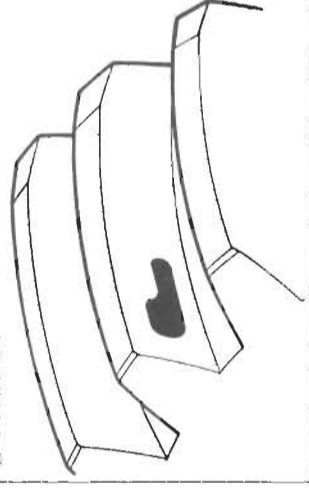

③ INCORRECT (Contact at tooth root)

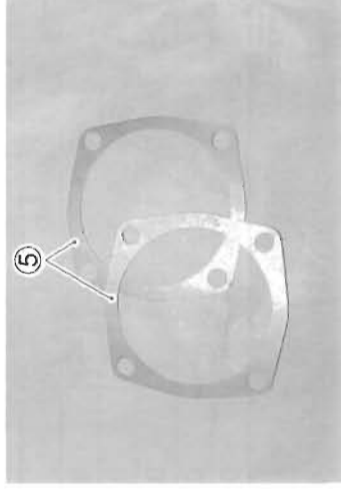
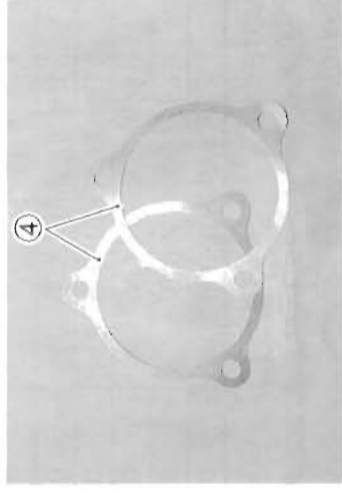
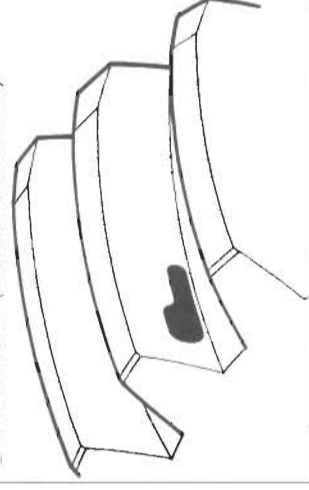
**REASSEMBLY****SECONDARY DRIVEN BEVEL GEAR**

- Apply grease to the lip of oil seal.

⚙️ 99000-25030: SUZUKI SUPER GREASE "A" (For USA)
99000-25010: SUZUKI SUPER GREASE "A"
 (For the others)



- Tighten the bearing stopper to the specified torque with the special tool.

⚙️ Bearing stopper: 105 N·m (10.5 kgf·m, 76.0 lb-ft)

🔧 09921-21820: Bearing retainer wrench

**SECONDARY DRIVE BEVEL GEAR**

Reassemble the secondary drive bevel gear in the reverse order of disassembly. Pay attention to the following points.

- When installing a new circlip, pay attention to the direction of the circlip. Fit the circlip to the side where the thrust is, as shown in the illustration. The rounded side should be against the output cam dog surface.

▲ CAUTION

* Never reuse a circlip. After a circlip has been removed from a shaft, it should be discarded and a new circlip must be installed.

* When installing a new circlip, do not expand the end gap larger than required to slip the circlip over the shaft.

* After installing a circlip, make sure that it is completely seated in its groove and securely fitted.

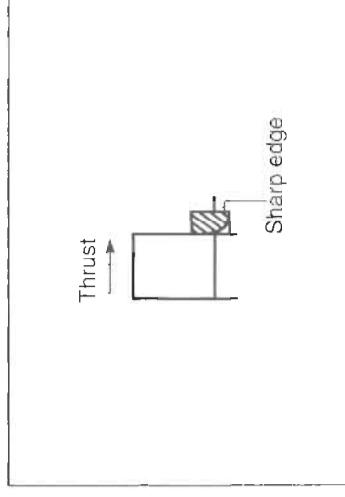
**INSTALLATION**
SECONDARY DRIVEN BEVEL GEAR/
SECONDARY DRIVE BEVEL GEAR

- Refer to the engine reassembly sections. Engine reassembly 3-53

FINAL BEVEL GEARS CONSTRUCTION

ITEM	N.m	kgf.m	lb-ft
A	23	2.3	16.5
B	9	0.9	6.5
C	40	4.0	29.0
D	100	10.0	72.5

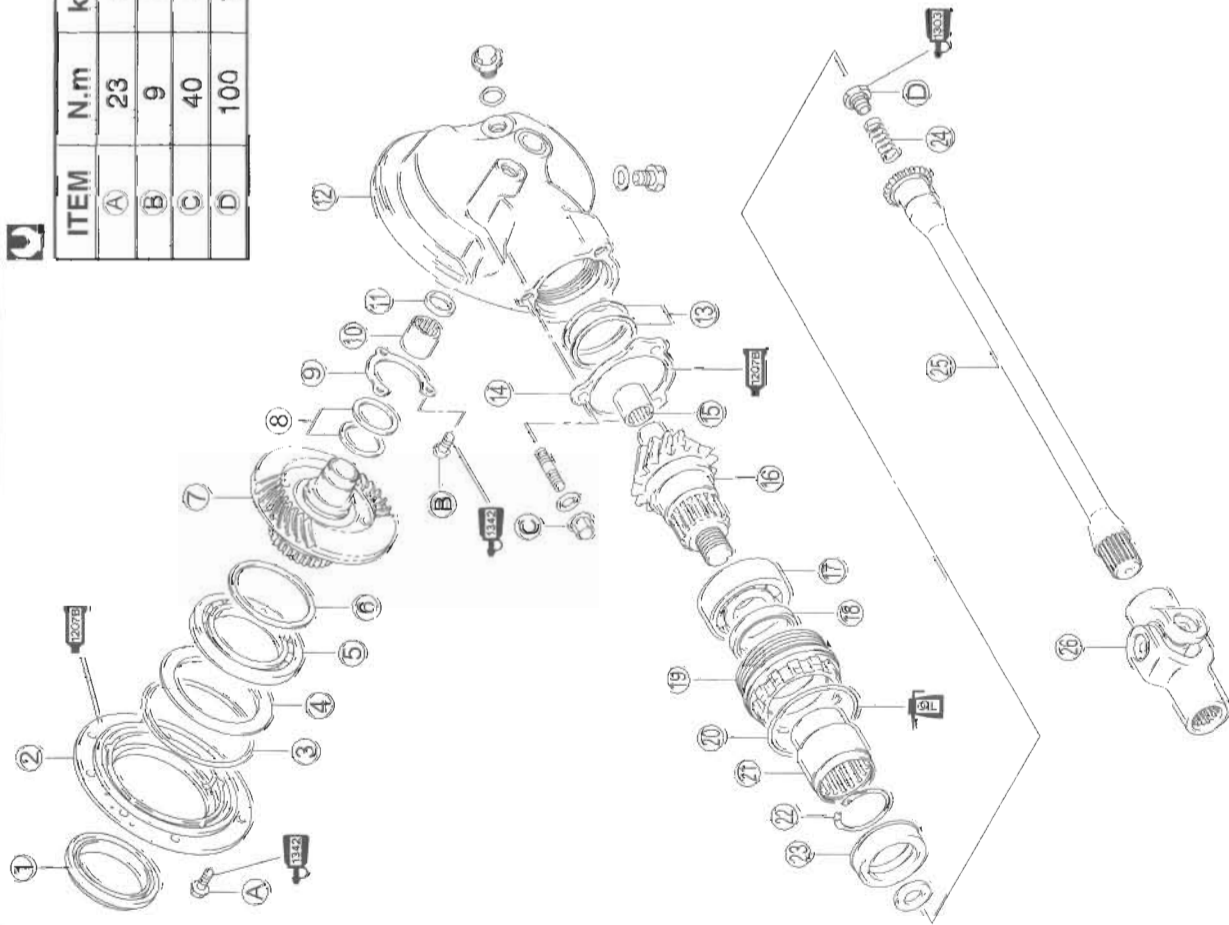

- (A) Final gear case bolt
- (B) Final driven bevel gear bearing retainer screw
- (C) Final gear case nut
- (D) Final driven bevel gear coupling nut
- (1) Oil seal
- (2) Final gear bearing case
- (3) O-ring
- (4) Plate
- (5) Final driven gear bearing
- (6) Shims (4 kinds)
- (7) Final driven bevel gear
- (8) Shims (8 kinds)
- (9) Bearing retainer
- (10) Final driven gear bearing
- (11) Oil seal
- (12) Final gear case
- (13) Shims (5 kinds)
- (14) Stopper plate (2 kinds)
- (15) Final drive gear bearing
- (16) Final drive bevel gear
- (17) Final drive bevel gear bearing
- (18) Oil seal
- (19) Bearing stopper
- (20) O-ring
- (21) Final drive coupling
- (22) Circlip
- (23) Oil seal
- (24) Spring
- (25) Propeller shaft
- (26) Universal joint

Standard clearance (C): 1.00 mm (0.039 in)

Shim (3) size table

Part number	Thickness
27327-34200	0.35 mm (0.014 in)
27327-34210	0.40 mm (0.016 in)
27327-34220	0.50 mm (0.020 in)
27327-34230	0.60 mm (0.024 in)

The shims (3) are available as a set (27327-34810).

Standard clearance (A): 1.00 mm (0.039 in)

Shim (1) size table

Part number	Thickness
27445-38A00-030	0.30 mm (0.012 in)
27445-38A00-035	0.35 mm (0.014 in)
27445-38A00-040	0.40 mm (0.016 in)
27445-38A00-050	0.50 mm (0.020 in)
27445-38A00-060	0.60 mm (0.024 in)

The shims (1) are available as a set (27445-38810).

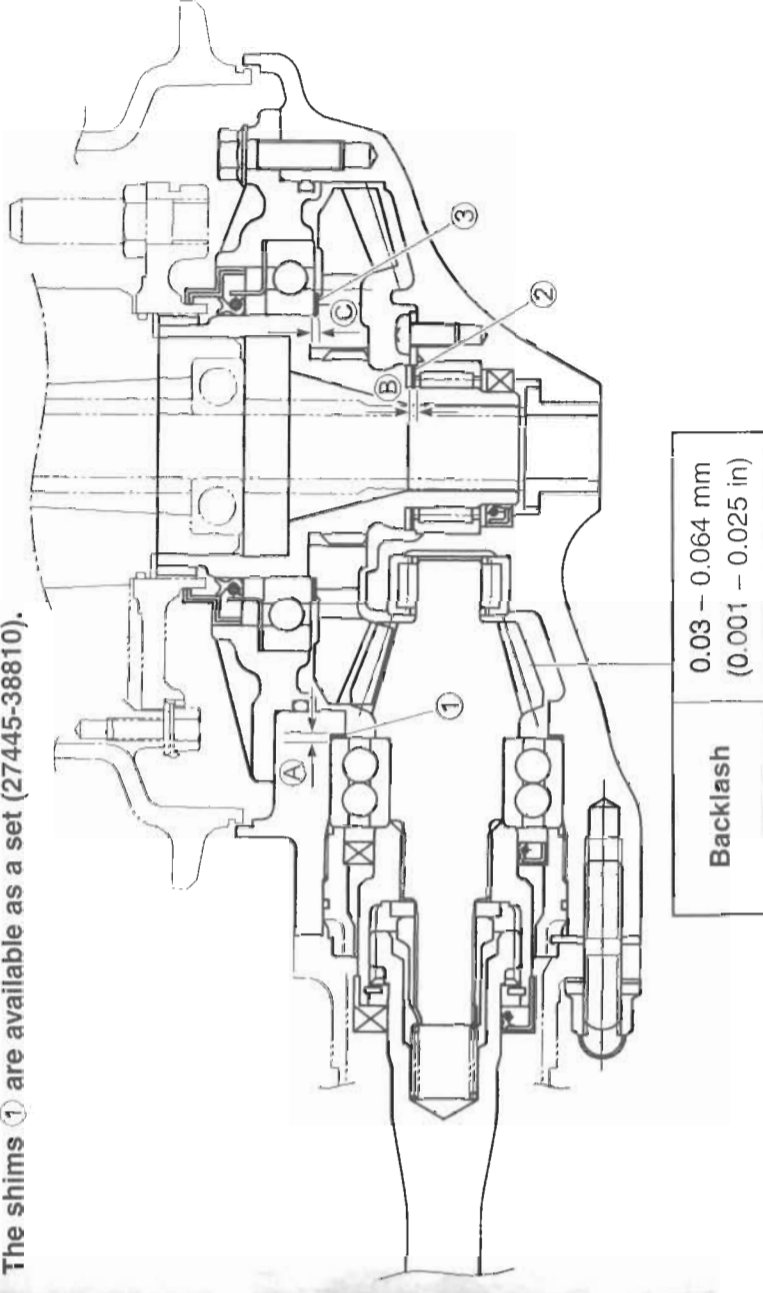

Standard clearance (B): 2.3 mm (0.091 in)

Shim (2) size table

Part number	Thickness
27326-34201	1.05 mm (0.041 in)
27326-34211	1.10 mm (0.043 in)
27326-34221	1.20 mm (0.047 in)
27326-34231	1.25 mm (0.049 in)
27326-34241	1.35 mm (0.053 in)
27326-34201-140	1.40 mm (0.055 in)
27326-34201-145	1.45 mm (0.057 in)
27326-34201-150	1.50 mm (0.059 in)

The shims (2) are available as a set (27326-34810 (1.40 - 1.50), 27326-34820 (1.05 - 1.35)).

FINAL GEAR CASE REMOVAL

After draining final gear oil, the following components must be removed in the described order before removing the final gear case.

NOTE:

Refer to the following pages for the details of each step.

- Drain final gear oil. (7-2-15)
- Remove the rear wheel. (7-38)

- Remove the final gear case.



FINAL GEAR CASE DISASSEMBLY

- Remove the plate ①.

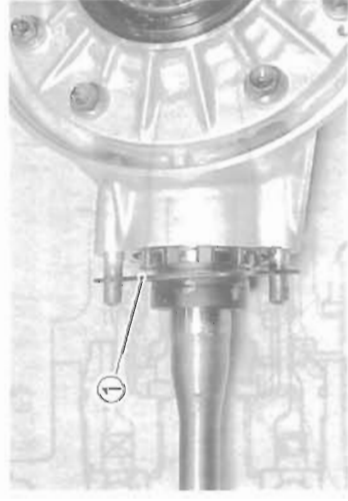

- Remove the oil seal ②.

CAUTION

The removed oil seal must be replaced with a new one.

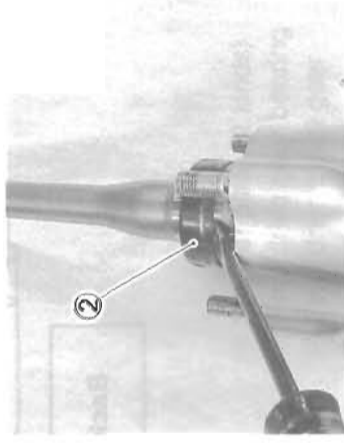

- Remove the circlip with the special tool and take off the propeller shaft and spring.

TOOL 09900-06108: Snap ring pliers

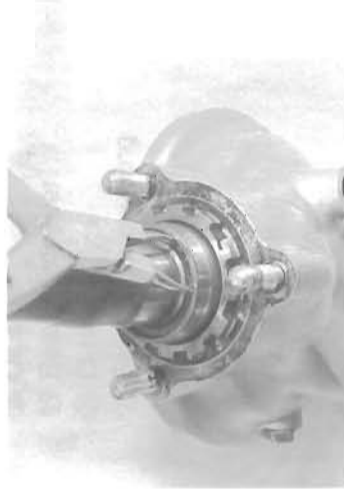

- ① Spring
- ② Propeller shaft
- ③ Circlip

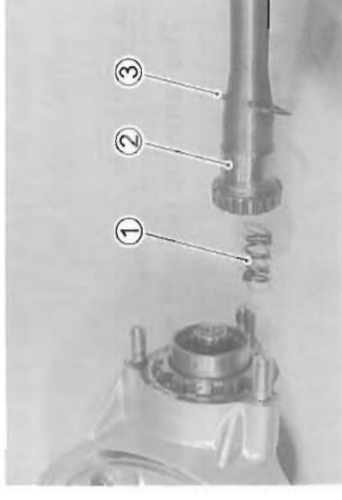

- Using a chisel, unlock the nut.
- Remove the final drive bevel gear coupling nut with the special tool.

TOOL 09924-62430: 22 mm Long socket
09924-64510: Final drive gear coupling holder

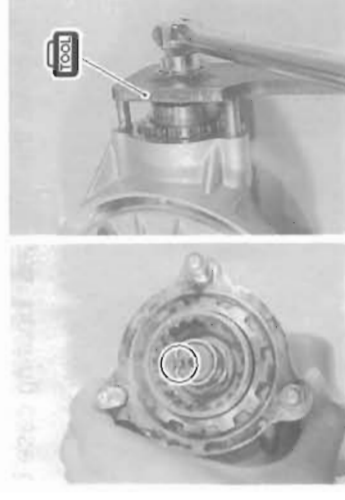

- Remove the washer and the final drive coupling.

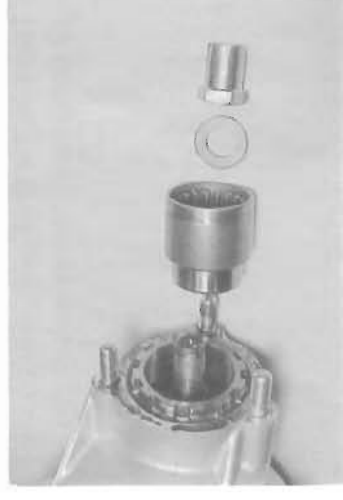

- Remove the bearing stopper by using the special tool.

TOOL 09924-62410: Final drive gear bearing holder wrench



- Remove the final drive bevel gear and shims.



- Remove the bearing from the final drive bevel gear with the bearing puller.

CAUTION

The removed bearing must be replaced with a new one.

NOTE:

If no abnormal noise, the bearing removal is not necessary.

- Remove the final gear bearing case bolts.

- Remove the final gear bearing case from the final gear case, by using two 5 mm screws.

- Remove the final driven bevel gear and shims.

- Remove the oil seal with the special tool.

TOOL 09913-50121: Oil seal remover

NOTE:

If no oil leakage, the oil seal removal is not necessary.

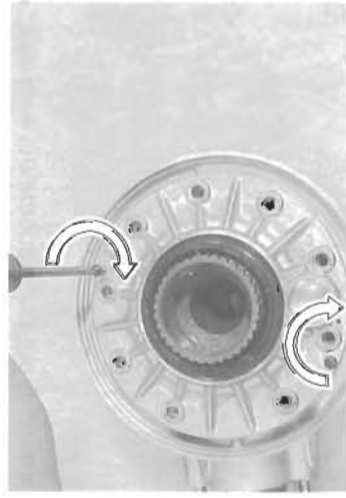
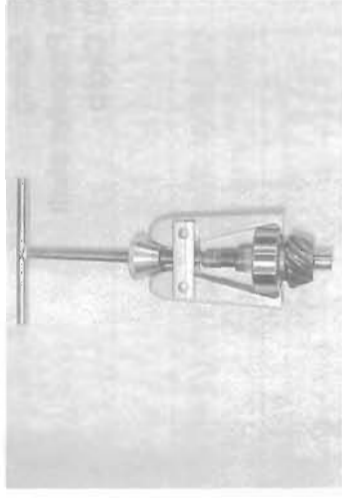

- Remove the bearing retainer screws, using an impact driver set.

TOOL 09900-09004: Impact driver set



- Remove the final driven gear bearing and oil seal with the special tools.

TOOL 09941-64511: Bearing remover
09930-30102: Sliding shaft

CAUTION

The removed bearing and oil seal must be replaced with new ones.

NOTE:

If no abnormal noise, the bearing removal is not necessary.

- Remove the final drive gear bearing with the special tools.

TOOL 09923-73210: Bearing remover
09930-30102: Sliding shaft

CAUTION

The removed bearing must be replaced with a new one.

NOTE:

If no abnormal noise, the bearing removal is not necessary.

- Remove the oil seal ① and O-ring ② from the bearing stopper.

CAUTION

The removed oil seal and O-ring must be replaced with new ones.

NOTE:

If no oil leakage, the oil seal removal is not necessary.

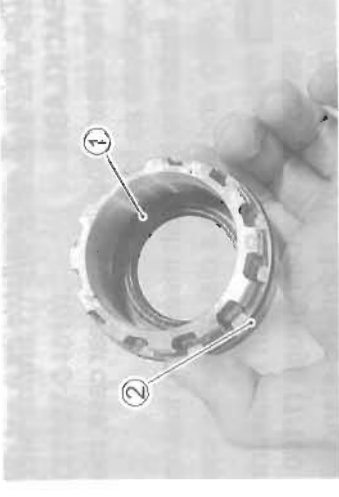

INSPECTION

Inspect the removed parts for the following abnormalities.

- Drive and driven bevel gear damage or wear
- Improper tooth contact
- Abnormal noise of bearings
- Bearing damage or wear
- Oil seal damage or wear
- Propeller shaft spline damage or wear

FINAL GEAR SHIMS ADJUSTMENT

FINAL GEAR BEARING CASE SHIM CLEARANCE

- Install the final driven gear, shims (1) and (2) and final gear bearing case to the final gear case.

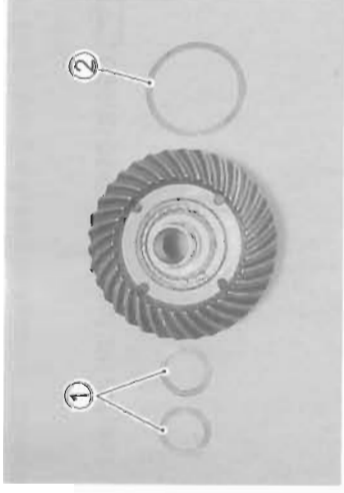

- Tighten the final gear case bolts to the specified torque.

Final gear case bolt: 23 N·m (2.3 kgf·m, 16.5 lb-ft)

NOTE:

It is not necessary to apply SUZUKI BOND "1207B" to the matching surface at this stage.

- Measure the clearance between the shims and bearing. If it is not within the specification, the shims must be changed.

Standard

Final gear case shim clearance

Standard: 1.00 mm (0.039 in)

Shims 2 specifications

Part No.	Shim thickness
27327-34200	0.35 mm (0.014 in)
27327-34210	0.40 mm (0.016 in)
27327-34220	0.50 mm (0.020 in)
27327-34230	0.60 mm (0.024 in)

NOTE:

The shims 2 are available as a set (27327-34910).

BACKLASH

After assembling the final gear case, measure the final bevel gear backlash as follows.

- Install the backlash measuring tool on the drive bevel gear coupling, and set-up a dial gauge as shown in photo.

09924-34510: Backlash measuring tool (27 - 50 mm)

09900-20606 : Dial gauge (1/100 mm, 10 mm)

09900-20701 : Magnetic stand

- Adjust the dial gauge so that it touches the backlash measuring tool arm at the mark; hold the final driven bevel gear securely, and turn the final drive bevel gear coupling slightly in each direction, reading the total backlash on the dial gauge.

Final bevel gear backlash

Standard: 0.03 - 0.64 mm (0.001 - 0.025 in)

If the backlash is not within the specification, adjust the shim thickness as follows:

- Remove shims from final gear bearing case and final gear case, and measure total thickness.

In order not to change the clearance between final driven bevel gear and bearing, the total thickness of the shims installed after a change is made must equal the original total thickness of shims.

- If backlash is too large:

a) Install a thinner shim pack 1 between final driven bevel gear and final gear case.

b) Increase thickness of shims 2 between final driven bevel gear bearing and bearing case by an amount equal to decrease above.

- If backlash is too small:

a) Install a thicker shim pack 1 between final driven bevel gear and final gear case.

b) Decrease thickness of shims 2 between final driven gear bearing and bearing case by an amount equal to increase above.

EXAMPLE:

Final gear to case shims 1; 1.45 mm + 1.40 mm = 2.85 mm

Final gear bearing to bearing case shims 2,

0.35 mm + 0.60 mm = 0.95 mm

Original total measurement = 3.80 mm

Backlash too large:

Final gear to case shims 1; 1.35 mm + 1.45 mm = 2.80 mm

Final gear bearing to bearing case shims 2,

0.60 mm + 0.40 mm = 1.00 mm

Total thickness = 3.80 mm

Backlash too small:

Final gear to case shims 1; 1.50 mm + 1.40 mm = 2.90 mm

Final gear bearing to bearing case shims 2;

0.50 mm + 0.40 mm = 0.90 mm

Total thickness = 3.80 mm

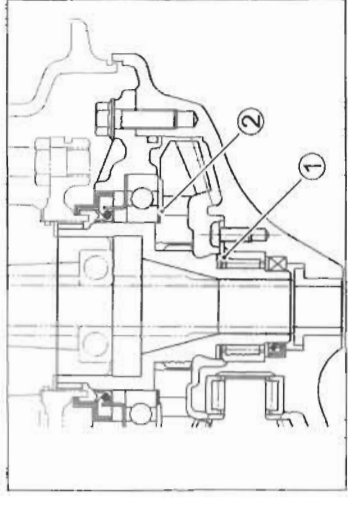

Shims 1 specifications

Part No.	Shim thickness
27326-34201	1.05 mm (0.041 in)
27326-34211	1.10 mm (0.043 in)
27326-34221	1.20 mm (0.047 in)
27326-34231	1.25 mm (0.049 in)
27326-34241	1.35 mm (0.053 in)
27326-34201-140	1.40 mm (0.055 in)
27326-34201-145	1.45 mm (0.057 in)
27326-34201-150	1.50 mm (0.059 in)

The shims 1 are available as a set {27326-34810 (1.40 - 1.50), 27326-34820 (1.05 - 1.35)}.

Shims 2 specifications

Part No.	Shim thickness
27327-34200	0.35 mm (0.014 in)
27327-34210	0.40 mm (0.016 in)
27327-34220	0.50 mm (0.020 in)
27327-34230	0.60 mm (0.024 in)

The shims 2 are available as a set (27327-34810).



TOOTH CONTACT

After backlash adjustment is carried out, the tooth contact must be checked.

- Remove the bolts from the final gear bearing case, and remove the case with the two 5 mm screws. (C-4-14) Do not misplace the shims. Remove the final driven bevel gear.
- Clean and de-grease several teeth on the final driven bevel gear. Coat these teeth with machinist's dye or paste, preferably of a light color.
- Re-install the final driven bevel gear with shims in place, positioning the coated teeth so that they are centered on the final drive bevel gear.
- Re-install the final gear bearing case and bolts, and tighten to specification.

Final gear case bolt: 23 N·m (2.3 kgf·m, 16.5 lb-ft)

- Using a socket and handle on the final drive bevel gear coupling nut, rotate the final drive bevel gear several turns in each direction, while loading the final driven bevel gear. This will provide a contact pattern on the coated teeth of the driven bevel gear.
- Remove the final gear bearing case and final driven bevel gear, and inspect the coated teeth of the driven bevel gear. The contact patch should be as shown at right:
- If the tooth contact pattern is incorrect, as shown in ①, a thinner shim ④ is needed between the final drive bevel gear bearing and final gear case.
- If the tooth contact pattern is incorrect, as shown in ③, a thicker shim ④ is needed between the final drive bevel gear bearing and final gear case.
- If the tooth contact pattern is incorrect for either reason, the appropriate shim must be installed, and the tooth contact pattern rechecked by repeating the tooth coating procedure above.

NOTE:

If it is necessary to adjust the shim ④ thickness between final drive bevel gear bearing and final gear case, the final gear backlash may change, and should be re-checked according to the procedure outlined under the Backlash Measurement sub-section. Both adjustments may be needed until both backlash and tooth contact are correct.

① INCORRECT (Contact at tooth top)



② CORRECT

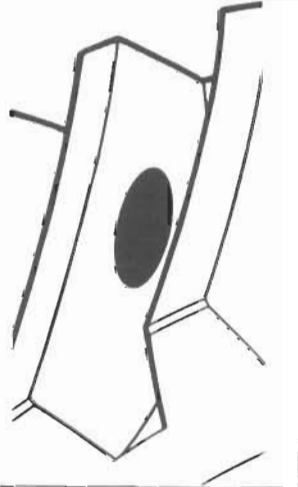

③ INCORRECT (Contact at tooth root)

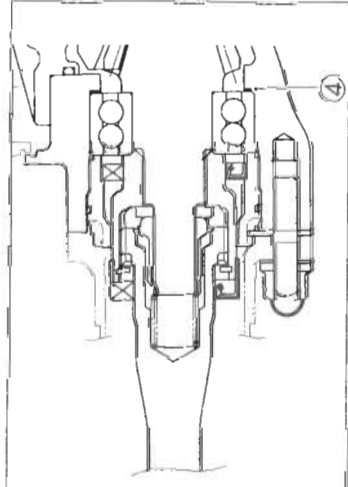
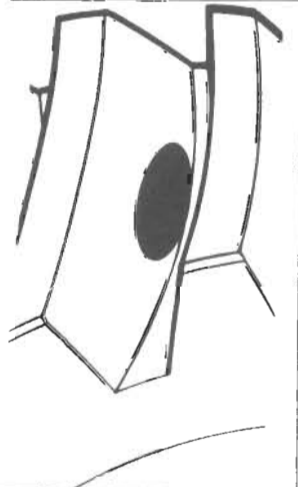

Shims ④ specification

Part No.	Shim thickness
27445-38A00-030	0.30 mm (0.012 in)
27445-38A00-035	0.35 mm (0.014 in)
27445-38A00-040	0.40 mm (0.016 in)
27445-38A00-050	0.50 mm (0.020 in)
27445-38A00-060	0.60 mm (0.024 in)

The shims ④ are available as a set (27445-38810).

FINAL GEAR CASE REASSEMBLY

Reassemble the final gear case in the reverse order of disassembly. Pay attention to the following points.

- Install a new oil seal ① and O-ring ② to the bearing stopper.

▲ CAUTION

Use new O-ring and oil seal to prevent oil leakage.

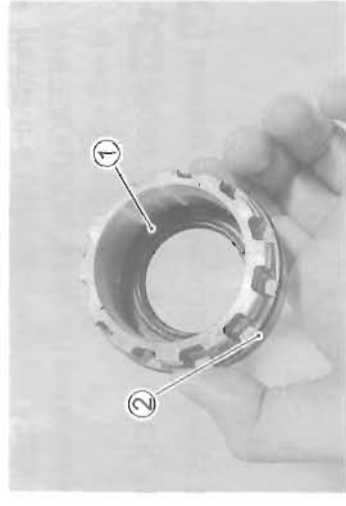

- Install the bearing to the final drive bevel gear with the special tool.

09913-84510: Bearing installer

▲ CAUTION

When replacing the drive bevel gear, replace the driven bevel gear also, as they must be replaced together.

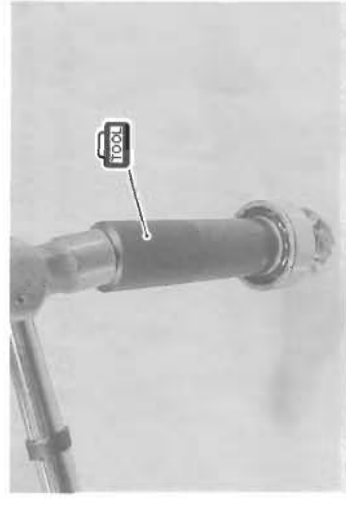

- Install the needle roller bearing for the final drive bevel gear into the final gear case with the special tool.

09913-75821 : Bearing installer

- Install the oil seal into the final gear case.

▲ CAUTION

- * Use a new oil seal to prevent oil leakage.
- * The lip and spring of the oil seal should face to the driven bevel gear side.

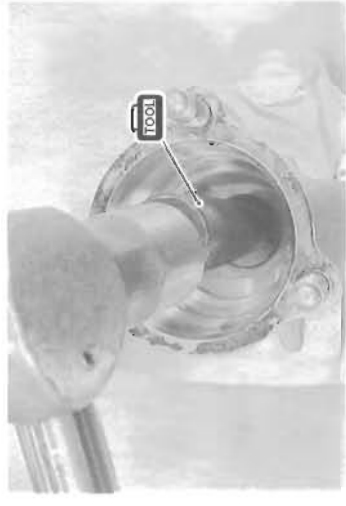

- Install the needle roller bearing for the final driven bevel gear into the final gear case with the special tool.

TOOL 09913-76010: Bearing installer

NOTE:

The stamped ward on the bearing end should face to the driven bevel gear side.

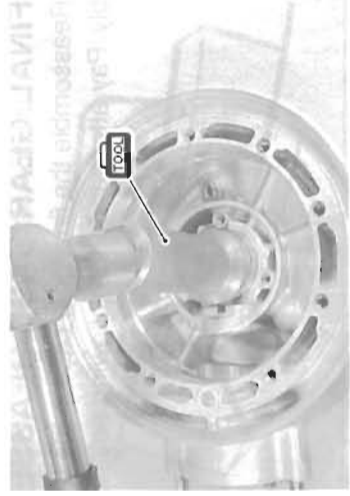

- Install the bearing retainer. Apply a small quantity of the THREAD LOCK "1342" on the screws, and tighten them to the specified torque.

TOOL 1342 99000-32050: THREAD LOCK "1342"

TOOL Bearing retainer screw: 9 N·m (0.9 kgf·m, 6.5 lb·ft)

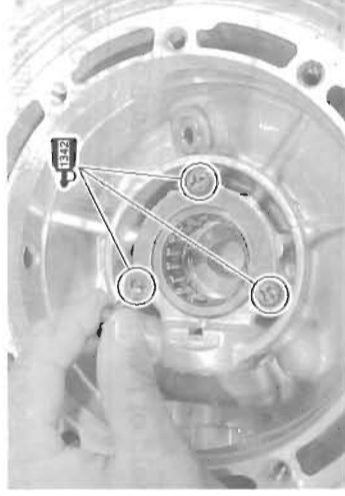

- Install a new oil seal to the final gear bearing case.
- Apply final gear oil to the lip of the oil seal.

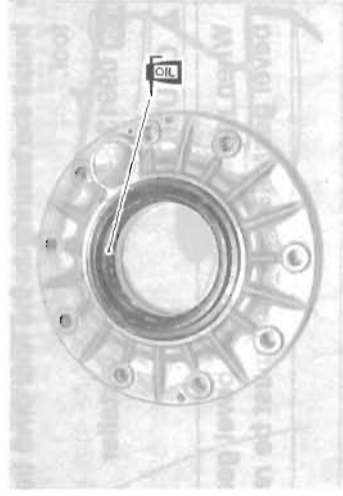

- Apply SUZUKI BOND "1207B" to the mating surface of the final gear case and final gear bearing case.

CAUTION

Do not block the breather passage when applying SUZUKI BOND "1207B".

TOOL 99000-31140: SUZUKI BOND "1207B"

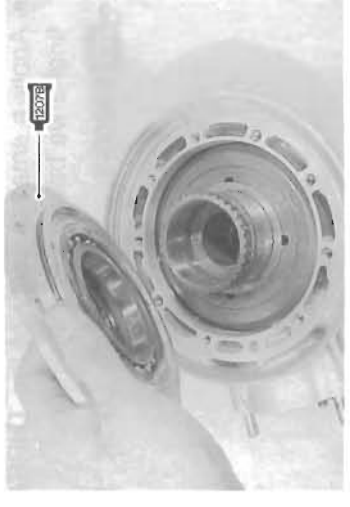

- Apply THREAD LOCK "1342" to the final gear case bolts and tighten them to the specified torque.

TOOL Final gear case bolt: 23 N·m (2.3 kgf·m, 16.5 lb·ft)

TOOL 1342 99000-32050: THREAD LOCK "1342"



- Install the correct shims to the final drive bevel gear and install the bevel gear to the final gear case.
Shim adjustment (4-16)



- Apply oil to the O-ring and the oil seal.
- Install the bearing stopper.

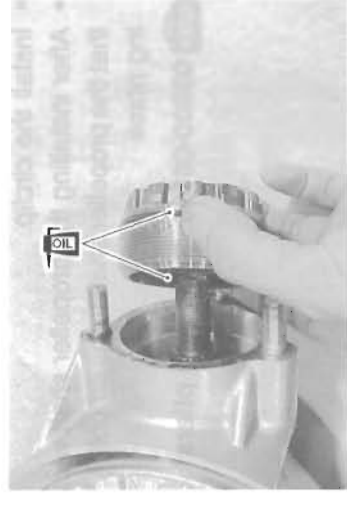

- Tighten the bearing stopper to the specified torque with the special tool.

TOOL 09924-62410: Final drive gear bearing holder wrench

TOOL Final drive bevel gear bearing stopper: 110 N·m (11.0 kgf·m, 79.5 lb·ft)

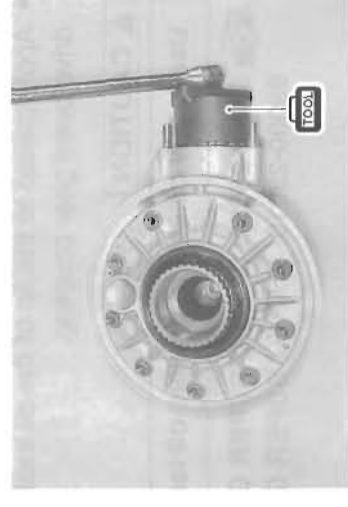

- Install the needle roller bearing for the final driven bevel gear into the final gear case with the special tool.

TOOL 09913-76010: Bearing Installer

NOTE:

The stamped ward on the bearing end should face to the driven bevel gear side.

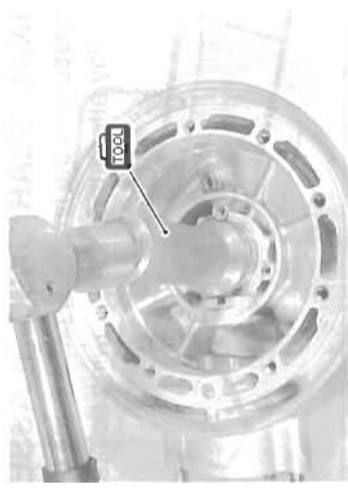

- Install the bearing retainer. Apply a small quantity of the THREAD LOCK "1342" on the screws, and tighten them to the specified torque.

TOOL 1342 99000-32050: THREAD LOCK "1342"

TOOL Bearing retainer screw: 9 N·m (0.9 kgf·m, 6.5 lb·ft)

- Install a new oil seal to the final gear bearing case.
- Apply final gear oil to the lip of the oil seal.

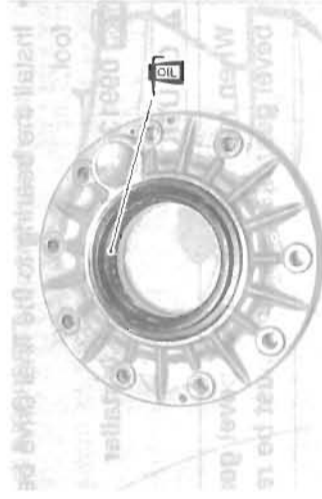
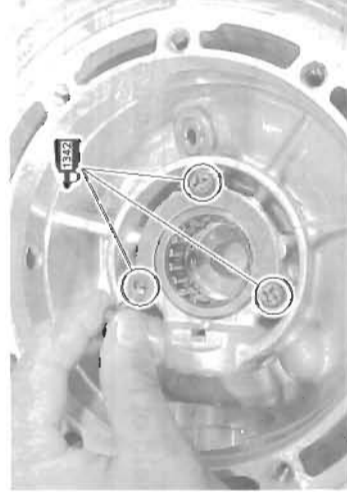

- Apply SUZUKI BOND "1207B" to the mating surface of the final gear case and final gear bearing case.

CAUTION

Do not block the breather passage when applying SUZUKI BOND "1207B".

TOOL 1207B 99000-31140: SUZUKI BOND "1207B"

- Apply THREAD LOCK "1342" to the final gear case bolts and tighten them to the specified torque.

TOOL Final gear case bolt: 23 N·m (2.3 kgf·m, 16.5 lb·ft)

TOOL 1342 99000-32050: THREAD LOCK "1342"

- Install the correct shims to the final drive bevel gear and install the bevel gear to the final gear case.
Shim adjustment (4-16)

- Apply oil to the O-ring and the oil seal.
- Install the bearing stopper.

- Tighten the bearing stopper to the specified torque with the special tool.

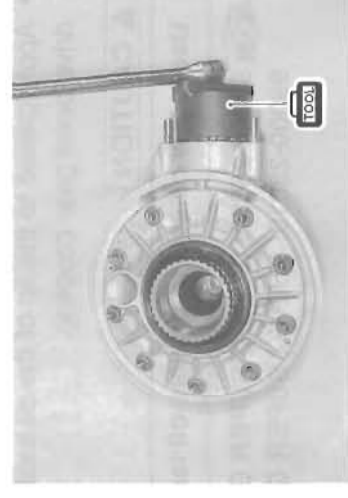
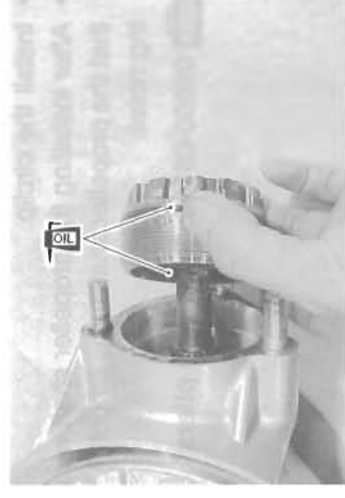

TOOL 09924-62410: Final drive gear bearing holder wrench

TOOL Final drive bevel gear bearing stopper: 110 N·m
(11.0 kgf·m, 79.5 lb·ft)



- Apply a small quantity of the **THREAD LOCK "1303"** to the final drive bevel gear coupling nut.



- Tighten the nut to the specified torque with the special tool.
-  **Final drive bevel gear coupling nut: 100 N·m (10.0 kgf·m, 72.5 lb-ft)**
-  **09924-62430: 22 mm Long socket**
09924-64510: Final drive gear coupling holder
- Lock the final drive bevel gear coupling nut with a center punch.

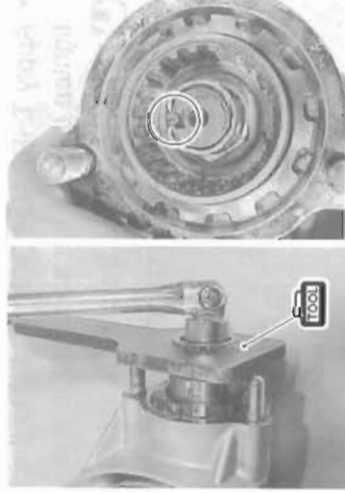

- Apply Lithium Base Molybdenum grease (NLGI #2) to the propeller shaft splines and final drive bevel gear coupling.
- Install the spring ① and propeller shaft ②.

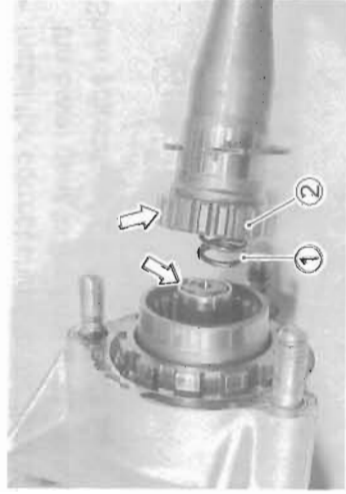

- Install the circlip.
- After installing the propeller shaft with a new circlip, make sure that the propeller shaft turns smoothly without any hitch or bearing noise.

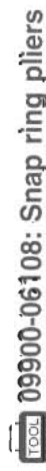

- Apply grease to the lip of the oil seal and install it to the final drive bevel gear coupling.



Use a new oil seal to prevent oil leakage.

-  **99000-25030: SUZUKI SUPER GREASE "A" (For USA)**
99000-25010: SUZUKI SUPER GREASE "A"
 (For the others)

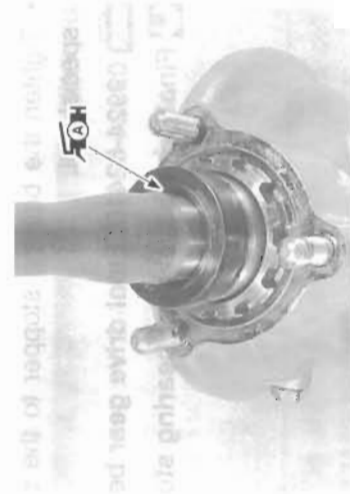
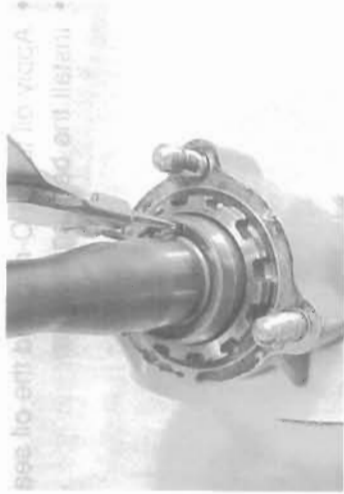

- Install the stopper plate.

CAUTION

When installing the plate, fit the protrusion  of plate to the one of the bearing stopper grooves.

NOTE:

Two kinds of plates are available to lock the stopper at the proper position.

FINAL GEAR CASE INSTALLATION



Installation is in the reverse order of removal.

NOTE:

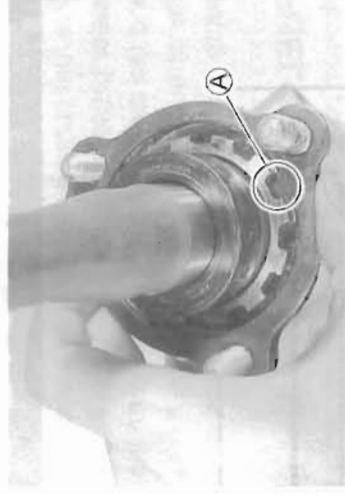
- Refer to the following pages for the details of each step.
- Install the final gear case.



- Tighten the final gear case bolts to the specified torque.
-  **Final gear case nut: 40 N·m (4.0 kgf·m, 29.0 lb-ft)**

- Install the rear wheel. ( 7-41)
- Pour final gear oil. ( 2-15)